















THE LEADING FORCE behind liquids™ since 1857



High Capacity Bulk Liquid Handling Pumps

- For loading/unloading transport truck tankers, railway tank cars, and barges
- High flow rate transfer capability in process plants and refineries

The Roper Pump Family of Rotary Pumps

| | | Typical Applications | Primary Features |
|---|------|--|---|
|  | 3600 | <ul style="list-style-type: none"> Mix, circulate, and transfer viscous liquids Gasoline, asphalt, molasses Ink, roofing compounds, oils | <ul style="list-style-type: none"> Precise tolerances for maximum efficiency Direct drive or built-on gear reducers Bi-directional rotation* Configurations available for close coupled drive and close coupled hydraulic drive |
|  | Z | <ul style="list-style-type: none"> Industrial applications requiring a special mechanical seal | <ul style="list-style-type: none"> ANSI Flanges Many parts interchangeable with 3600 Series Direct drive or built-on gear reducers Bi-directional rotation* Configurations available for close coupled drive and close coupled hydraulic drive |
|  | 4456 | <ul style="list-style-type: none"> Oilfields including light & heavy crude oil Condensates, waste oil, & well treatment chemicals | <ul style="list-style-type: none"> Four heavy-duty ball bearings Reversible wearplates Quick-fit, wear-resistant bronze seal cartridge |
|  | Bulk | <ul style="list-style-type: none"> Fuels, solvents, petrochemicals Residual fuel oils, molasses, resins Tankers, barges, process plants, refineries | <ul style="list-style-type: none"> Large ports (6" and 8" available) allow more efficient transfer of fluids Thru port design allows for lower inlet and outlet losses |
|  | 5600 | <ul style="list-style-type: none"> Hydroseeding Grouting, seal coating, oil and sand Wastewater, waste oil, sludge, slurries Brine, paper pulp, fertilizer feeds | <ul style="list-style-type: none"> Rubber covered gears Bi-directional rotation Abrasive applications; up to pea size particles |
|  | A | <ul style="list-style-type: none"> Pressure lubrication Hydraulic service General transfer applications | <ul style="list-style-type: none"> Operates at motor speeds Bi-directional rotation* Close coupled capability |
|  | 2835 | <ul style="list-style-type: none"> Roofing Compounds Molasses Feed Supplements | <ul style="list-style-type: none"> Operates at standard motor speeds Large ports allow easier fluid entry Built-in relief valve |
|  | V | <ul style="list-style-type: none"> Hazardous liquid transfer "Zero leakage" applications due to environmental concerns Chemical and petroleum applications | <ul style="list-style-type: none"> Mag-drive, sealless design eliminates seal repair costs and down time C-face mount eliminates misalignment Bi-directional rotation and self-priming |
|  | F | <ul style="list-style-type: none"> Hydraulic power for lifts, machine actuation, fuel burners, and blenders General transfer of oil and petroleum fluids | <ul style="list-style-type: none"> 2 inlet ports, 2 outlet ports allows multiple piping arrangements (except F150 - F300) High Pressure Range Maintain pump without pipe removal |
|  | ROC | <ul style="list-style-type: none"> Chemical processing Pharmaceutical industry Injection or transfer of acids & solvents | <ul style="list-style-type: none"> Stainless steel construction Bi-directional rotation Mag-drive, sealless option (X5-03 only) |
|  | 9622 | <ul style="list-style-type: none"> Chemical and transport applications Corrosive liquid transfer | <ul style="list-style-type: none"> 316SS Housing 17-4 PH SST Gears / Shafts Built-in Relief Valve |
|  | PC | <ul style="list-style-type: none"> Viscous, abrasive and solids-containing liquids Transfer of wastewater sludge, polymers, grouts, paints and adhesives | <ul style="list-style-type: none"> Pulsation free pumping High suction lift capabilities Ideal for shear sensitive liquids |

*Pump reconfiguration may be required.

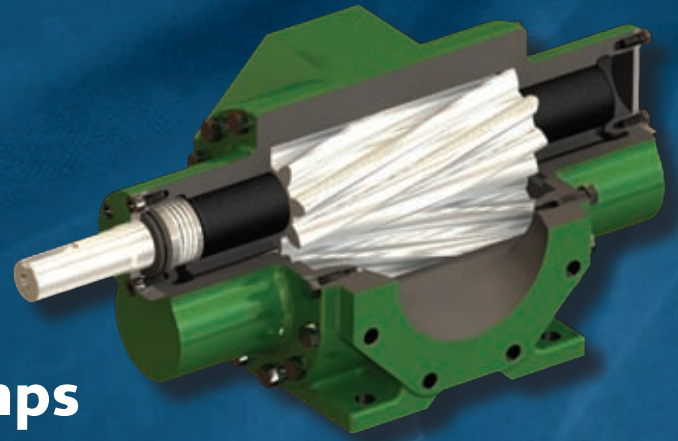

High Capacity Bulk Liquid Handling Pumps

For loading and unloading transport truck tankers, railway tank cars and barges, and high flow rate transfer in process plants and refineries

Flow rates up to 1,045 GPM ● Pressures up to 125 PSI

The rugged Bulk Liquid Handling pumps are built for high capacity transfer of a wide range of products from palm oil, biofuels, and solvents to molasses and resins, and the 6" model fulfills a broad range of application requirements in the petroleum processing industry*.

The large ports, precise tolerances, and large gear length-to-diameter ratio result in high efficiency fluid transfer. Each gear and integral shaft are supported by two heavy-duty bearings, avoiding the wear and premature failure inherent with an overhung shaft, and extending the service life of the pump.

The Bulk Liquid Pumps are manufactured and assembled with the highest quality materials of construction and are tested regularly in our ISO 9001 certified facility to insure dependable performance. Desired flow direction, in relation to driver rotation, can be established by assembly of the pump in either high or low drive, and proper endplate orientations (high drive, clockwise rotation is standard).

MATERIALS OF CONSTRUCTION

Standard Fitted

| | |
|----------------------------|---------------------------|
| Housing..... | Cast Iron |
| Gears..... | Case Hardened Alloy Steel |
| Bearings..... | Babbit Filled Carbon |
| Drive & Idler Shafts | Case Hardened Alloy Steel |

Optional Materials

| | |
|---------------|---------------|
| Housing..... | Ductile Iron |
| Bearings..... | Bronze Carbon |

**Optional materials may be required.*

FEATURES

- Designed to operate at standard motor speeds
- Permissible relatively high operating speeds provide advantages in driver size and fewer complications in gear reduction
- Bi-directional rotation**

Rugged, Long-Lasting Bearings

- Four heavy duty sleeve bearings give positive support to pumping gears, ensuring long, efficient service.

- Each bearing is grooved to allow circulation of the pumped liquid for bearing lubrication and temperature control.

Quiet-Running Helical Gears

- Accurate machining ensures proper meshing, reduced friction and vibration, and long life.
- Large length-to-diameter ratio reduces slip and improves the efficiency of the pump

Precise, Rugged, Maintenance-Friendly Design

- Precise manufacturing tolerances provide minimum clearances for maximum pumping efficiency.
- Back pull-out design simplifies maintenance and eliminates pipe disturbance.

***Pump reconfiguration required*

THE LEADING FORCE behind liquids™ since 1857

Bulk Liquid Pumps

| Pump Model | Theoretical Capacity | Maximum Speed | Maximum Flow at Maximum Speed (0 Discharge Pressure) | Maximum Pressure | Port Connection |
|------------|-----------------------|---------------|--|-------------------|-----------------|
| 4659/4759 | 0.63 GPR (2.38 l/rev) | 1200 RPM | 756 GPM (2862 l/min) | 125 PSI (8.6 Bar) | 6" ANSI Flange |
| 4668/4768 | 0.70 GPR (2.65 l/rev) | 1200 RPM | 845 GPM (3199 l/min) | 125 PSI (8.6 Bar) | 8" ANSI Flange |
| 4699/4799 | 1.05 GPR (3.98 l/rev) | 1000 RPM | 1045 GPM (3956 l/min) | 125 PSI (8.6 Bar) | 8" ANSI Flange |

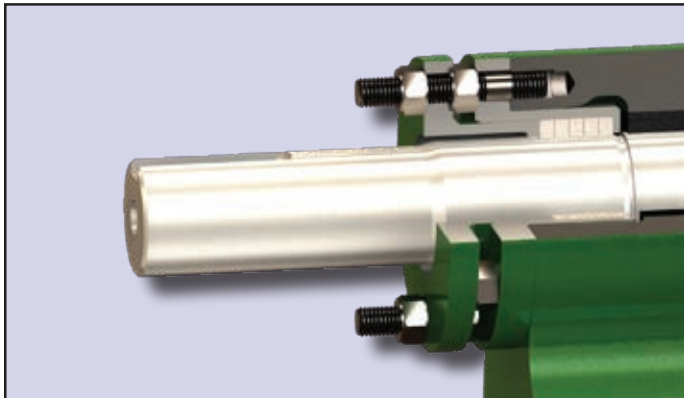

PACKED BOX (46XX)

The packed box seal is suited for general purpose applications, and should be adjusted to allow slight seepage for lubrication. The standard Teflon impregnated packing is compatible with a wide range of fluids, from gas and solvents to acids and caustics.

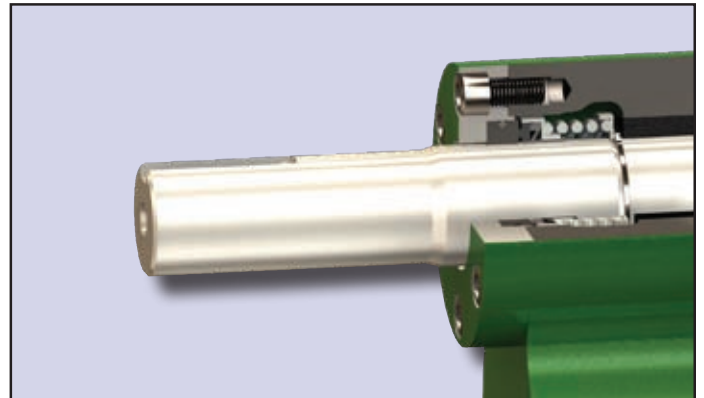

MECHANICAL SEAL (47XX)

The compact, simple lapped-face mechanical seal requires minimum power and assures long service life. No adjustment is needed, and seal components are easily accessible if service becomes necessary. Standard Viton elastomer is compatible with a wide range of liquids.

BASEPLATES AND DRIVES

All Bulk Series pumps are available on baseplates that are custom-designed for each application to ensure product reliability. The customer has a variety of drive options including electric, gas, or diesel engine, and hydraulic drives for maximum versatility.

LOWER COST OF OWNERSHIP

Each pump is designed with only two moving parts to minimize wear and prevent premature failure.

The three models that comprise the Bulk Liquid Series share the same parts with the exception of gears and cases. This parts commonality eliminates the need to maintain inventory for each model, reducing the cost of ownership.

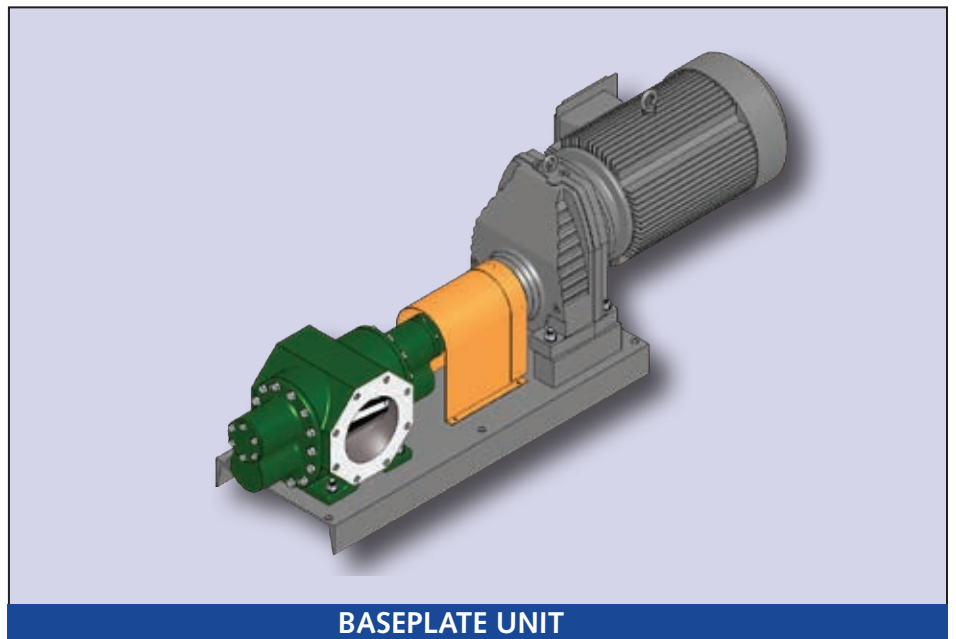

BASEPLATE UNIT

Dimensions and Performance Data

inches [millimeters]

| Pump | A | B | C | 1/2F | F | AD | NM | OA | Bolt Circle | 150lb ANSI Flange | Port |
|-----------|----------------|----------------|----------------|---------------|----------------|----------------|----------------|----------------|----------------|-------------------|---------------|
| 4659/4759 | 12.00 [305] | 11.00 [279] | 31.56 [802] | 4.50 [114] | 9.00 [229] | 12.25 [311] | 18.64 [473] | 14.54 [369] | 9.50 [241] | 6" | 6.00 [152] |
| 4668/4768 | 11.75 [298] | 12.75 [324] | 33.23 [844] | 5.00 [127] | 10.00 [254] | 12.00 [305] | 19.50 [495] | 13.38 [340] | 11.75 [298] | 8" | 8.00 [203] |
| 4699/4799 | 11.75 [298] | 12.75 [324] | 33.23 [844] | 5.00 [127] | 10.00 [254] | 12.00 [305] | 19.50 [495] | 13.38 [340] | 11.75 [298] | 8" | 8.00 [203] |

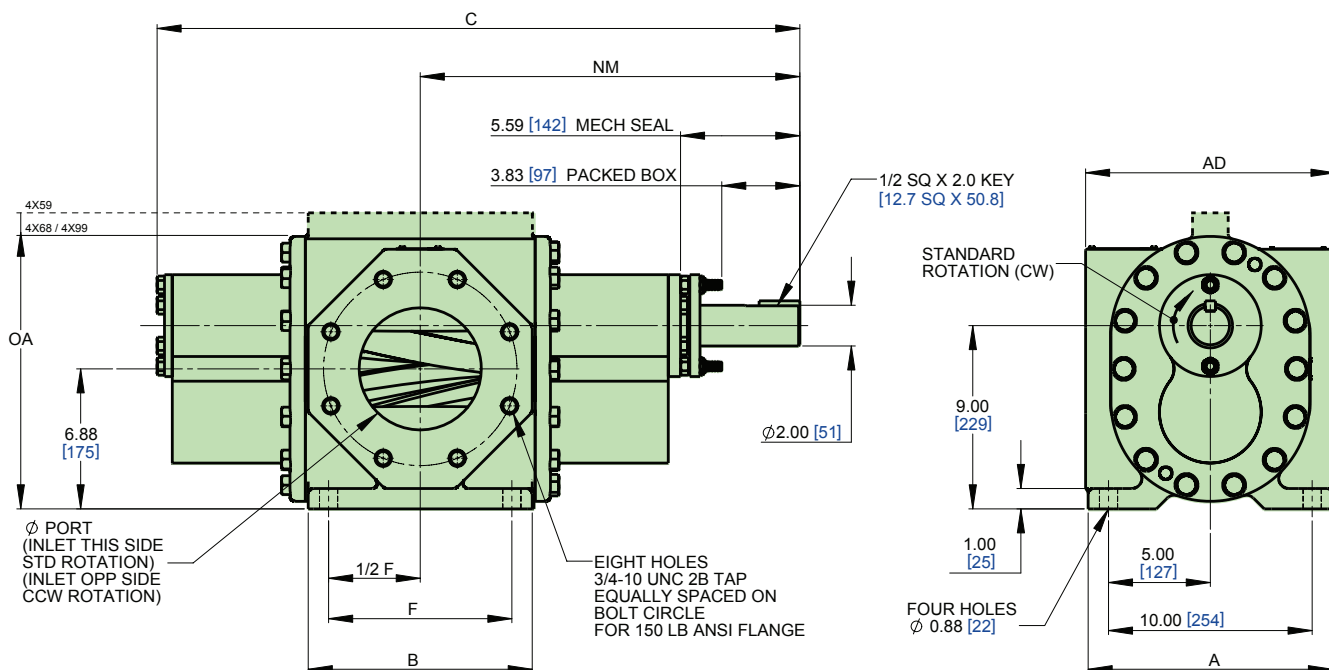

These curves show typical flow rates at various pump speeds. Actual flow rates will be determined by the inlet conditions at the pump, liquid characteristics, and temperature.

If there is any question concerning these curves or the recommended operating conditions, please consult your Roper Pump Distributor or Regional Sales Manager.

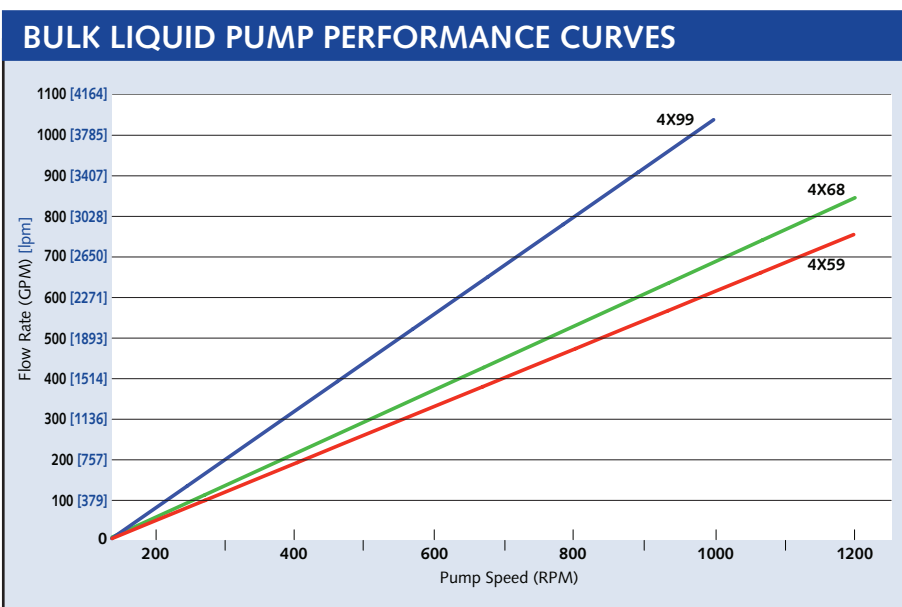



THE LEADING FORCE behind liquids™ since 1857

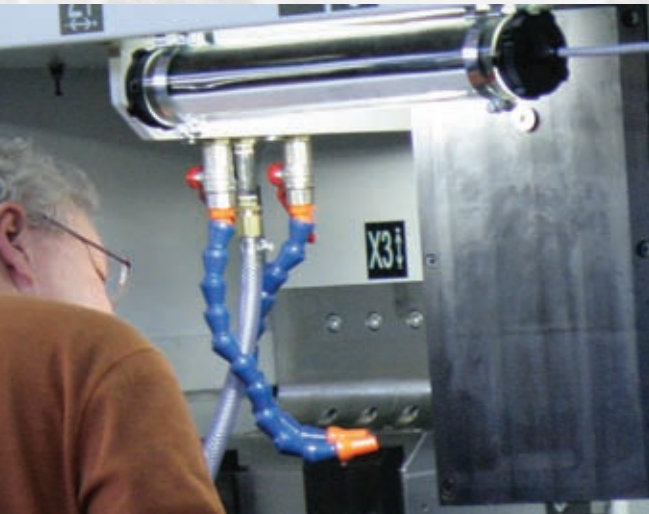

Roper Pump Company is a global supplier of high quality positive displacement pumps, designed to handle a broad range of industrial applications. In addition to helical gear pumps and progressing cavity pumps, we design and develop numerous custom pumps for customers with unique and demanding applications.

From a small pump company founded in 1857, Roper Pump Company has grown into a technological leader. With a large installed base, we have both the knowledge and experience to help you solve your most challenging pumping problems...and our strong global distribution network ensures that your needs are met on time, every time.

Our Markets



INDUSTRIAL

Roper Pump Company's rugged and dependable range of positive displacement pumps provides versatile pumping solutions for even the most challenging industrial applications.



TRANSPORT

With over a century of experience in liquid cargo transfer, Roper Pump Company has always been trusted to load and unload your tankers quickly and safely.



POWER GENERATION

For reliable operation of engines, compressors and turbines, thousands of customers depend on Roper Pump Company fuel pumps, lube pumps and liquid fuel flow dividers.



OIL & GAS

Roper Pump Company has numerous pumping solutions from the well to the refinery. Our industry leading High Performance Power Sections™ allow mud motors to run longer at unprecedented temperatures and depths.

Roper Pump Company

PO Box 269, 3475 Old Maysville Road
Commerce, GA 30529 USA

Customer Service: 706-336-3359

Technical Support: 706-336-3334

Fax: 706-335-5490

sales@roperpumps.com

www.roperpumps.com

©2009 by Roper Pump Company
Roper Pumps® is a registered trademark of Roper Pump Company.
THE LEADING FORCE behind liquids™ and High Performance Power Sections™ are trademarks of Roper Pump Company.
DOC# PB-BULK-E-R1