

Salamander Pumps 

So you want a really good shower?



RSP 100

Contents

Technological commitment	4
Help guidance and advice (PumpWise)	6
Warranty	7
ESP CPV Pumps for a quiet life	8
Quiet running high performance for showers and whole house systems	14
Typical RightPump and ESP applications	18
Plumber friendly pumps for showers	20
The fit and forget shower pumps for plumbers	22
Typical fit and forget applications	23
Anti-aeration flange	24
Anti-vibration couplers	25
General specification	26
Technical sales and accounts	27

If your existing shower is tank-fed and you need help in choosing the correct pump, then why not call sales...

Tel: 0845 377 9160

Fax: 0845 377 9180

Email: sales@salamanderpumps.co.uk

For technical help

Tel: 0845 129 5010

Do you dance around trying to get wet?



With the right Salamander pump you can enjoy the shower of your dreams. Softly cascading aerated bubbles will drench, caress, re-invigorate and refresh. This is a shower that will bring peace, comfort, and a feeling of well-being at the beginning or the end of every day.

Where the heart is

A technologically advanced and sophisticated electronic heart

All Salamander pumps are designed and engineered to ensure a long and maintenance free life. Every pump is individually tested for safety, performance and quality of workmanship.

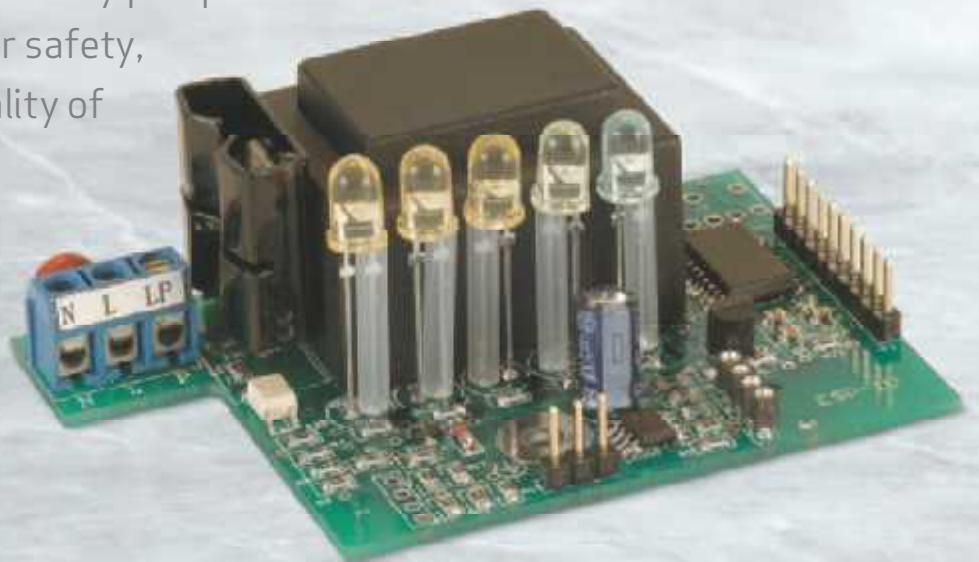

In pursuit of excellence and the indestructible pump – for a quiet life.

The Salamander range features pumps that boost the tank-fed Hot and Cold water services to baths, basins and showers in any domestic system.

All pumps are strong, durable and user friendly. The Salamander flagship pumps enjoy the security and protection of ESP – electronic sensor protection. This technologically advanced and sophisticated heart has been created especially by Salamander and can be found in our top of the range pumps such as the ESP 100 CPV twin featured here.



ESP 100 CPV twin

PumpWise

An initiative to help customers

PumpWise is the cornerstone of Salamander's support service to customers and the means by which our customers are guaranteed –

- Selection of the right pump for the job
- The avoidance of installation pitfalls
- A third year's warranty FREE

Selecting the right pump for the job

We offer technical assistance, guidance or advice to anyone who asks. Contact our Sales Department.

Eliminate the risk of an incorrect installation

If your installation is not straightforward or if you have any reservation or doubts contact our Technical Department.

Third year's warranty is completely free

To qualify for the 3rd year's warranty all you have to do is register and follow the engineer's advice. Contact our Technical Department.

On-site nationwide support

To resolve any on-site technical issues contact us. If required we can arrange for one of our Salamander service engineers to visit the installation.

A Salamander engineer will resolve your problem quickly over the phone, or if that's not possible, arrange an on-site visit.

Depending on the nature of your call and contact details – we guarantee to call you back at our expense.

For PumpWise help, guidance or advice simply call 0845 129 5010 (09.00-17.00 weekdays)

Sales: 0845 377 9160

Technical: 0845 129 5010

Fax: 0845 377 9180

E-mail: sales@salamanderpumps.co.uk

tech@salamanderpumps.co.uk

Warranty

Two years warranty

Salamander customers benefit from a two year warranty. This warranty will operate from date of purchase and is subject only to the installation guidelines being followed correctly.

PumpWise Third year warranty FREE

Under the PumpWise Scheme customers who consult Salamander on or before the date of installation, and who implement our recommendations, will benefit from a Third Year Warranty FREE.

Warranty The IEW Scheme

Your pump warranty can be extended indefinitely.

The IEW Scheme[®] (Indefinitely Extended Warranty) exists to protect customers from unexpected or unforeseen pump breakdown.

Under the IEW Scheme customers are guaranteed a no-quibble replacement pump FREE for however many years they decide to participate in the scheme; plus the years of the standard or PumpWise warranty whichever is applicable.

Participation in the IEW Scheme is activated on completion of a standing order mandate for payment of a nominal sum annually.



ESP CPV pumps

For a quiet life



ESP CPV Pumps are the culmination of four years intensive research to develop advanced pumps that incorporate micro-electronic technology and sensors. The result is showers that protect users from unexpected or unforeseen conditions.



The first intelligent shower and whole house booster to combine positive and negative head system applications in one pump – with a built-in pressure vessel and electronic system protection.

Pump protection and L.E.D. indication

- N** ● Negative head operation
- P** ● Positive head operation
- 1** ● System hunting protection
- 2** ● Dry run protection
- 3** ● Supply water temperature protection





ESP 50 CPV and ESP 75 CPV twin

Positive and/or negative head systems



ESP 75 CPV twin

Designed specifically for one/two bathroom systems where there is a need to boost baths, basins or showers which may be above and/or below the cold water storage tank(s).

Typically – flats, loft and barn conversions.

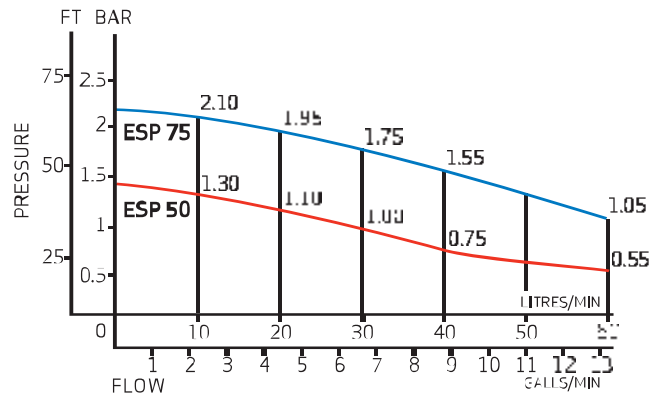

ESP 100 CPV and ESP 140 CPV twin







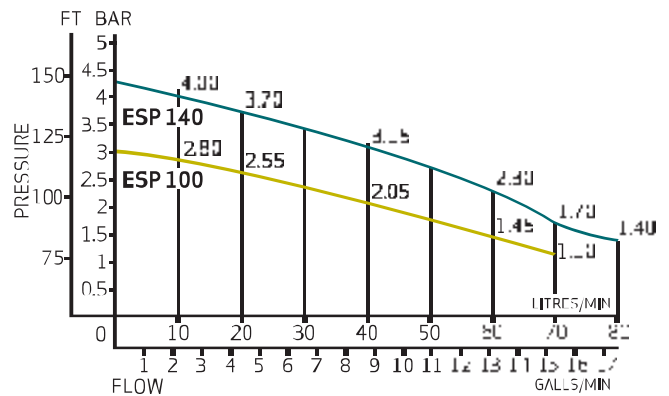

Positive and/or negative head systems











ESP 100 CPV twin

As ESP 50 CPV and ESP 75 CPV twin above, but also for systems where there is a need for greater performance or flow, e.g. shower columns, steam cubicles and multiple body sprays.



ESP CPV twin	ESP 50 CPV twin	ESP 75 CPV twin
<p>Applications For flats and houses where the requirement is for a positive and/or negative head pump.</p>	<p>New ESP 50 CPV for tank fed shower and/or whole house systems in flats and houses where the pressure requirement is up to 1.5 bar (30-42ft head).</p>	<p>New ESP 75 CPV as ESP 50 CPV – plus multiple shower systems where the pressure requirement is up to 2 bar (65-75ft head).</p>
<p>Performance Closed head pressure Max amps/watts Rating</p>	<p>Extremely Quiet 50ft head (1.5 bar) 1.8 amps/430 watts Continuous</p>	<p>Very Quiet 75ft head (2 bar) 3.2 amps/720 watts Continuous</p>
<p>Key</p> <ul style="list-style-type: none">  Watercan  Conventional spray  Multifunction massage – champagne spray  3 bar shower heads – e.g. Activa  Body sprays  Multiple body sprays 		

ESP CPV twin	ESP 100 CPV twin	ESP 140 CPV twin
<p>Applications As ESP 50/75 CPV above but where there may also be shower columns, steam cubicles or body sprays.</p>	<p>As ESP 75 above but also where there may be body sprays in systems where the pressure requirements is up to 3 bar (100ft head).</p>	<p>As ESP 100 CPV and where the pressure requirement is up to 4.3 bar typically in pre-formed shower columns and cubicles.</p>
<p>Performance Closed head pressure Max amps/watts Rating</p>	<p>Quiet 100ft head (3 bar) 4 amps/960 watts Continuous</p>	<p>Quiet 142ft head (4.3 bar) 6 amps/1440 watts 20 mins on/off</p>
<p>Key</p> <ul style="list-style-type: none">  Watercan  Conventional spray  Multifunction massage – champagne spray  3 bar shower heads – e.g. Activa  Body sprays  Multiple body sprays 		



ESP 80 CPV and ESP 120 CPV single

Positive and/or negative head systems



ESP 80 CPV single

These single pumps boost supplies to a variety of appliances from tank-fed systems, and are suitable for both positive and negative head systems. Selection should be based on pressure requirements.

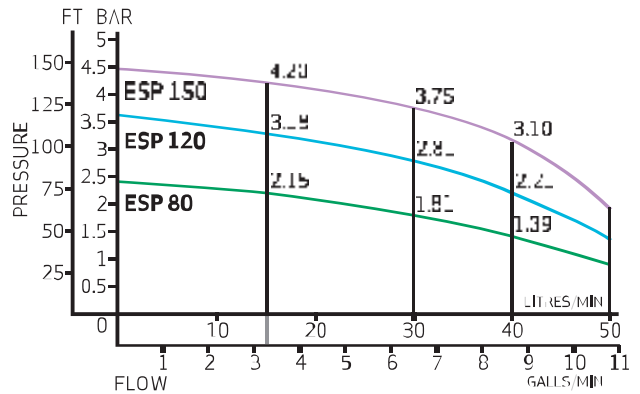

ESP CPV super boosters

Positive and/or negative head systems



ESP 120 CPV super boosters

The choice of super booster is determined by establishing the pressure required at the outlets. These boosters are suitable for both positive and negative head systems.

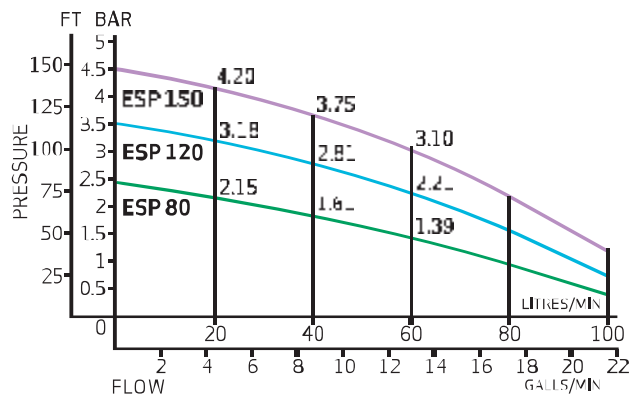

ESP CPV single	ESP 80 CPV single	ESP 120 CPV single	ESP 150 CPV single
----------------	-------------------	--------------------	--------------------

Applications To boost tank fed supplies to instantaneous electric showers, water heaters, washing machines and combination boilers – according to inlet pressure requirements. See PumpWise Installation and Warranty Guide.

Performance	Extremely Quiet	Very Quiet	Quiet
Closed head pressure	80ft head (2.42 bar)	120ft head (3.64 bar)	150ft head (4.5 bar)
Max amps/watts	2.4 amps/580 watts	2.7 amps/650 watts	5 amps/750 watts
Rating	Continuous	Continuous	30 mins on/off

Key

-  Watercan
-  Conventional spray
-  Multifunction massage - champagne spray
-  3 bar shower heads - e.g. Activa
-  Body sprays
-  Multiple body sprays

		
---	---	---



ESP CPV SB	ESP 80 CPV SB	ESP 120 CPV SB	ESP 150 CPV SB
------------	---------------	----------------	----------------

Applications Created to meet the requirements of those who live in larger houses or whose idea of a really good shower is a total deluge. Each Super Booster comprises two single pumps, one each to independently boost hot and cold water services. These pumps can be positioned together or remotely one from the other.

Performance	Extremely Quiet	Very Quiet	Quiet
Closed head pressure	80ft head (2.40 bar)	120ft head (3.64 bar)	150ft head (4.5 bar)
Max amps/watts	1.8 amps/430 watts	3.2 amps/720 watts	5 amps/750 watts
Rating	Continuous	Continuous	30 mins on/off

Key

-  Watercan
-  Conventional spray
-  Multifunction massage - champagne spray
-  3 bar shower heads - e.g. Activa
-  Body sprays
-  Multiple body sprays

		
---	---	---

RightPumps

FOR POWER SHOWERS

The showering sensation for life



There are people for whom a shower is functional rather than enjoyable. But the privileged few who have experienced the sheer joy of a really powerful shower find it almost impossible to live without one in their daily routine. To the initiated, a RightPump shower is in a different league to an ordinary shower and a fundamental part of luxury living.

The Salamander range of RightPumps has been specially created for these power shower enthusiasts.



It is a misconception that the right shower pump is the most powerful one the customer can afford. The right shower pump is best determined by the customer's expectations and their choice of shower head.



RSP 100



Right shower pumps

Positive head



RSP 100

Designed purely for showers, these twin-ended pumps boost the Hot and Cold supplies to Thermostatic or Manual Mixer valves. Each pump is capable of feeding two or three showers simultaneously.

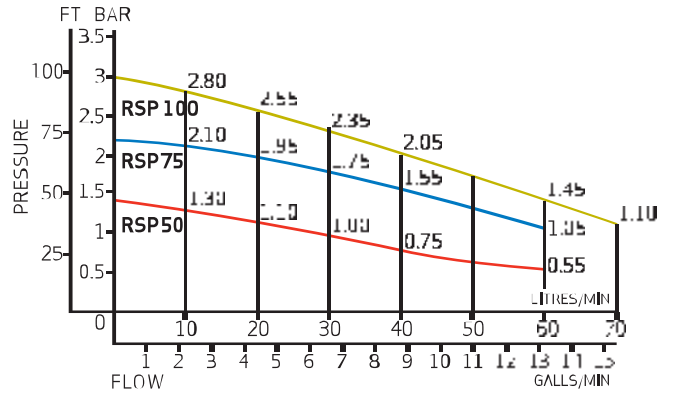

Right whole house pumps

Positive head



RHP 75

Designed specifically for whole house systems, or just the bathroom, these twin-ended pumps are uniquely equipped with a bypass loop.

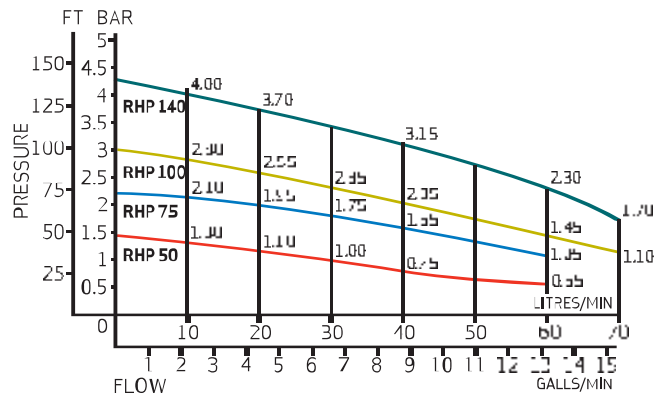

Right single pumps

Positive head



RGP 80

A new and innovative range of single outlet pumps. Compact and smooth running with sustained flow.

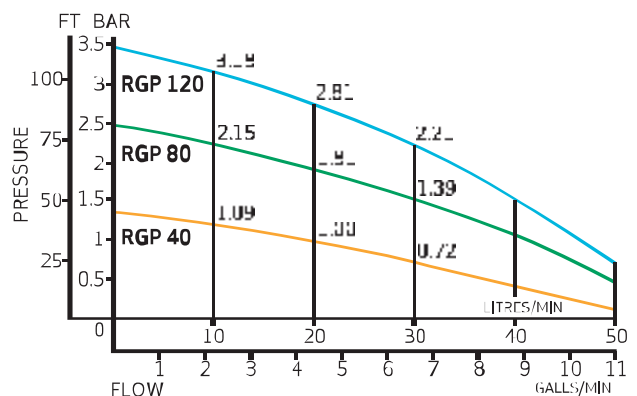

RightPump	RSP 50 twin	RSP 75 twin	RSP 100 twin	Key
<p>Applications Quiet running pumps for showers. Not suitable to boost toilets, washing machines or individual H/C taps.</p>	<p>Purpose made for one or more Victorian style 'can' type heads, or alternatively for more conventional type shower heads.</p>	<p>The ideal choice for multi-function shower heads with massage and champagne spray functions.</p>	<p>As RSP 75 plus up to four body (wall) sprays. Definitely the Right choice for 3 bar shower heads such as Activa.</p>	<p>Watercan Conventional spray Multifunction massage - champagne spray 3 bar shower heads - e.g. Activa Body sprays Multiple body sprays</p>
<p>Performance Closed head pressure Max amps/watts Rating</p>	<p>Extremely Quiet 50ft head (1.5 bar) 1.8 amps/430 watts Continuous</p>	<p>Very Quiet 75ft head (2 bar) 3.2 amps/720 watts Continuous</p>	<p>Quiet 100 ft head (3 bar) 4.0 amps/960 watts Continuous</p>	

RightPump	RHP 50 twin	RHP 75 twin	RHP 100 twin	RHP 140 twin
<p>Applications Quiet running, high performance pumps for the whole house including toilets, washing machines or individual H/C taps.</p>	<p>Whole house flats and houses with low resistance outlets.</p>	<p>Whole house flats and houses with high resistance outlets where there may also be showers with pulsating or champagne spray.</p>	<p>As RHP 75 twin, but where there may be body sprays and a shower system which requires min. 3 bar (100 ft. head) e.g. Activa.</p>	<p>Typically to preformed shower columns or cubicles or sophisticated shower systems which require high pressure.</p>
<p>Performance Closed head pressure Max amps/watts Rating</p>	<p>Extremely Quiet 50ft head (1.5 bar) 1.8 amps/430 watts Continuous</p>	<p>Very Quiet 75ft head (2 bar) 3.2 amps/720 watts Continuous</p>	<p>Quiet 100 ft head (3 bar) 4 amps/960 watts Continuous</p>	<p>Quiet 140 ft head (4.3 bar) 6 amps/1440 watts 20 mins on/off</p>

RightPump	RGP 40 single	RGP 80 single	RGP 120 single
<p>Applications The right single pump to boost supplies to a variety of appliances.</p>	<p>To boost hot, cold or mixed water supplies to a variety of outlets from a tank fed supply.</p>		
<p>Performance Closed head pressure Max amps/watts Rating</p>	<p>Extremely Quiet 43ft head (1.3 bar) 2.0 amps/480 watts Continuous</p>	<p>Very Quiet 80ft head (2.42 bar) 2.4 amps/580 watts Continuous</p>	<p>Quiet 115ft head (3.64 bar) 2.7 amps/650 watts Continuous</p>

Typical Right Pump and ESP CPV Pump applications

Positive head system

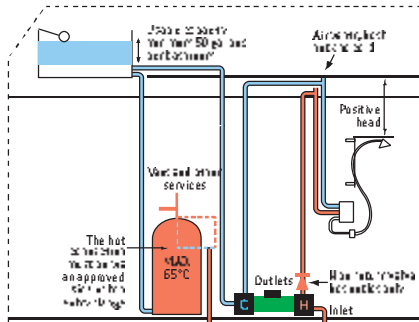

RSP Twin Pump with up and over pipework and natural flow of 1 Litre/min per side.

Pump fitted above cylinder

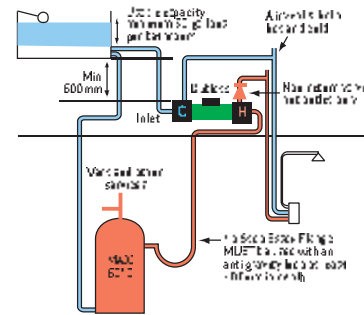

Pump fitted in loft above cylinder. Must use no stop Essex flange and anti-gravity loop.

Negative head system

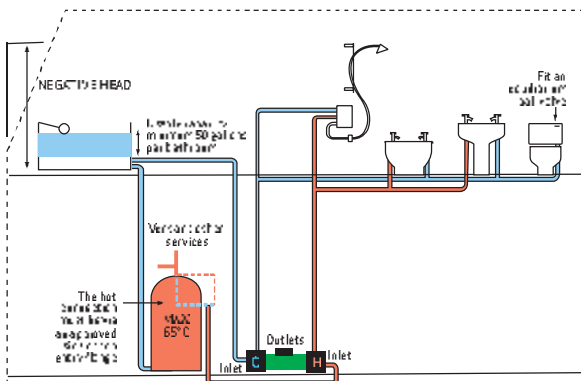

ESP CPV Twin Pump to a bathroom in a loft conversion.

Whole house system

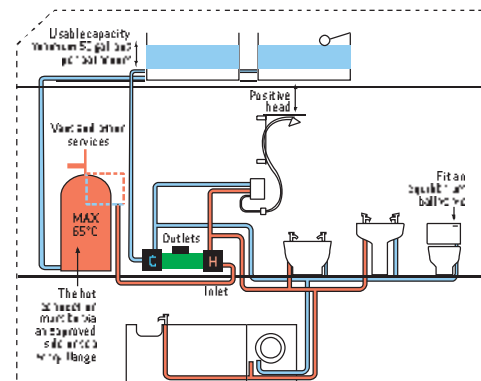

RHP Twin Pump on a whole house system.

Pump feeding two showers

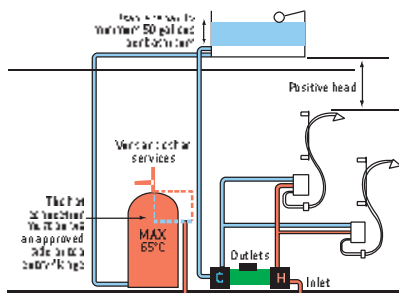

RSP Twin Pump feeding two showers.

Pump on steam cabinet

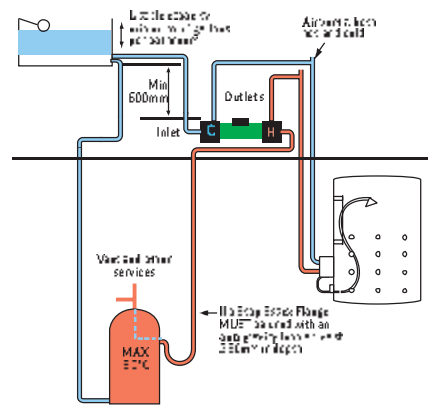

ESP CPV Pump fitted above cylinder on a steam shower cabinet.

Large whole house system

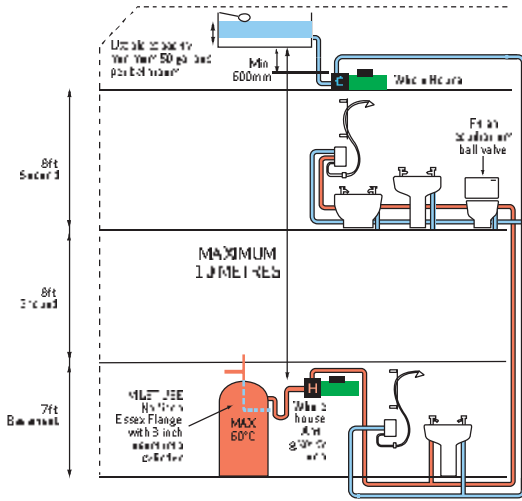

Large whole house system with the ESP CPV SB hot and cold pumps independently mounted with hot pump above cylinder.

Large whole house system

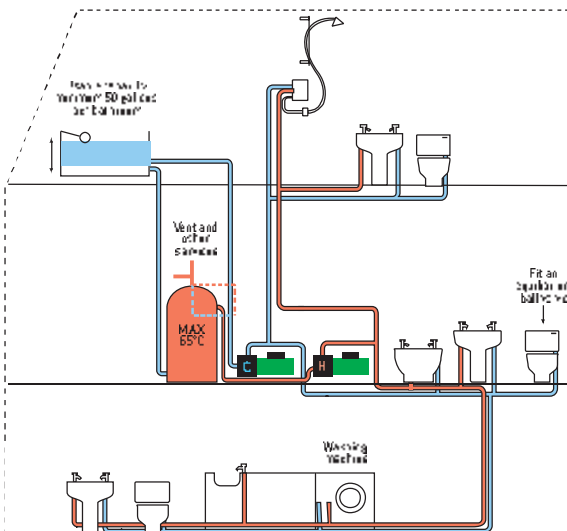

Large whole house system with the ESP CPV SB hot and cold pumps mounted in the airing cupboard.

Multiple showers

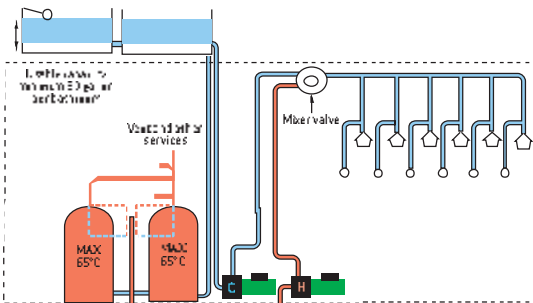

Sports complex with multiple showers.

Pumping hot water only

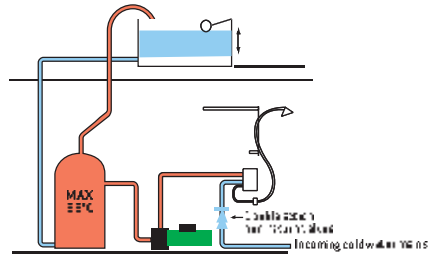

Tank fed (hot) with cw mains cold systems MUST USE Right ESP CPV.

Pumped tank supplies to combi or pressurised cylinder

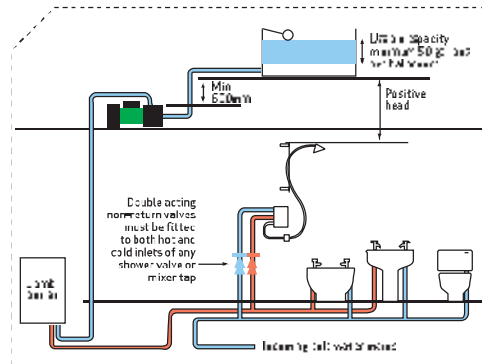

Tank fed, pressurised cylinder or combi boiler system with ESP CPV single to boost the hot supply water pressure and cold water mains supplies "cold" to shower, bath, basin and toilet.

Combi with CWS tank and cylinder

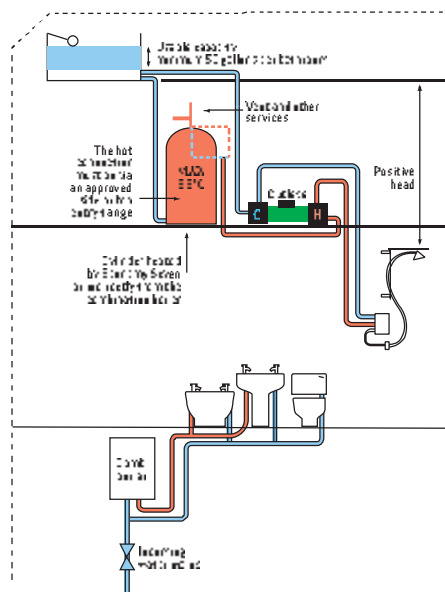

Combi boiler system with RSP twin pump to boost the shower from a CWS tank and a direct cylinder.

New Pearl pumps

The plumber friendly pumps for showers



New Pearl twins

Regenerative, positive head

Tough, easy to fit general purpose twin booster pumps. Designed purely to boost the hot and cold supplies to thermostatic or manual shower mixer valves.



NP 75

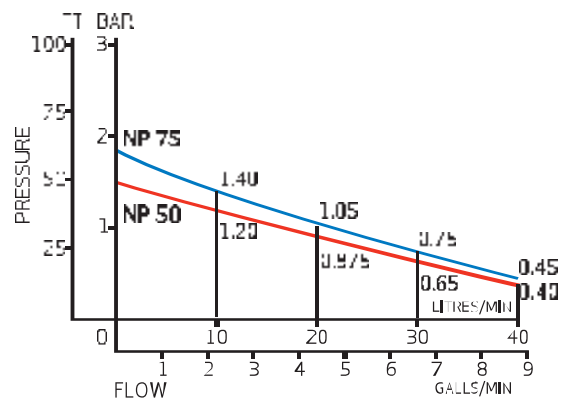

New Pearl singles

Regenerative, positive head

A new and innovative range of single outlet pumps.





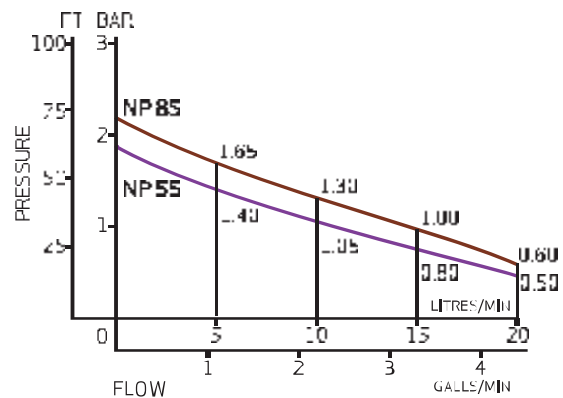







NP 85





New Pearl pumps complete with straight and angled push fit AV couplers with built-in isolating valves.

New Pearl twin	NP 50 twin	NP 75 twin
Applications Twin shower specific pumps	The plumber friendly pump for conventional showers or victorian can style shower heads.	A tough and robust choice for multi-function shower heads with massage and champagne functions.
Performance		
Closed head pressure	50ft head (1.50 bar)	75ft head (2.1 bar)
Max amps/watts	2.0 amps/480 watts	2.1 amps/500 watts
Rating	Continuous	30 mins on/off
Key  Watercan  Conventional spray  Multifunction massage - champagne spray		

New Pearl single	NP 55 single	NP 85 single
Applications To boost supplies to a variety of tank-fed appliances	To boost hot, cold or mixed water supplies to a variety of outlets from a tank fed supply.	
Performance		
Closed head pressure	55ft head (1.65 bar)	85ft head (2.57 bar)
Max amps/watts	2.0 amps/450 watts	2.1 amps/460 watts
Rating	Continuous	Continuous
Key  Watercan  Conventional spray  Multifunction massage - champagne spray		

CT pumps

The fit and forget shower pumps for plumbers



CT 50/75 twin

Regenerative, positive head



CT 50

Tough, easy to fit general purpose twin booster pumps. Designed purely to boost the hot and cold supplies to thermostatic or manual shower mixer valves.

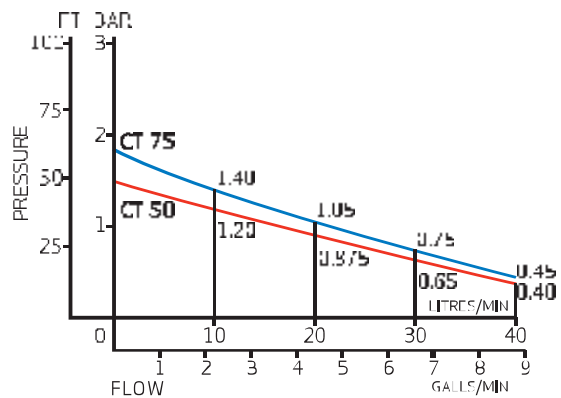

CT 55/85 single

Regenerative, positive head



CT 85

A new and innovative range of single outlet pumps.

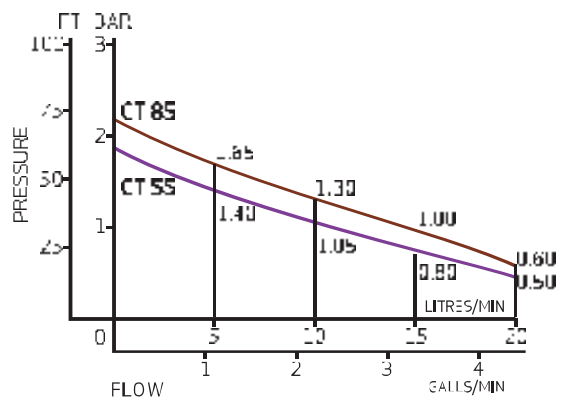



CT pumps – the quick and simple, easy to fit pumps with push fit AV couplers

Typical CT pump applications

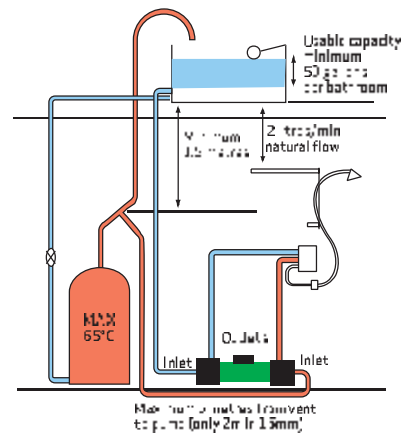

Exclusive hot and cold supplies to the pump with the hot from the vent angled at 45°.

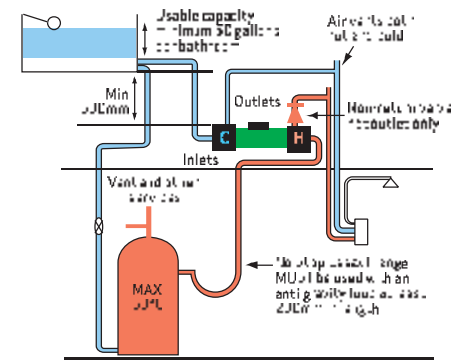

In positive head systems, allow for increased resistance of long pipe runs with multiple bends. The natural flow from the shower head or other outlets MUST be at least 1 litre/min per side (hot or cold).

CT twin	CT 50 twin	CT 75 twin
Applications Twin shower specific pumps	The plumber friendly pump for conventional showers or victorian can style shower heads.	A tough and robust choice for multi-function shower heads with massage and champagne functions.
Performance Closed head pressure Max amps/watts	50ft head (1.50 bar) 2.0 amps/480 watts	75ft head (2.1 bar) 2.1 amps/500 watts
Rating	Continuous	30 mins on/off

Key

- Watercan
- Conventional spray
- Multifunction massage - champagne spray

CT single	CT 55 single	CT 85 single
Applications To boost supplies to a variety of tank-fed appliances	To boost hot, cold or mixed water supplies to a variety of outlets from a tank fed supply.	
Performance Closed head pressure Max amps/watts	55ft head (1.67 bar) 2.0 amps/450 watts	85ft head (2.57 bar) 2.1 amps/460 watts
Rating	Continuous	Continuous

Key

- Watercan
- Conventional spray
- Multifunction massage - champagne spray



S flange

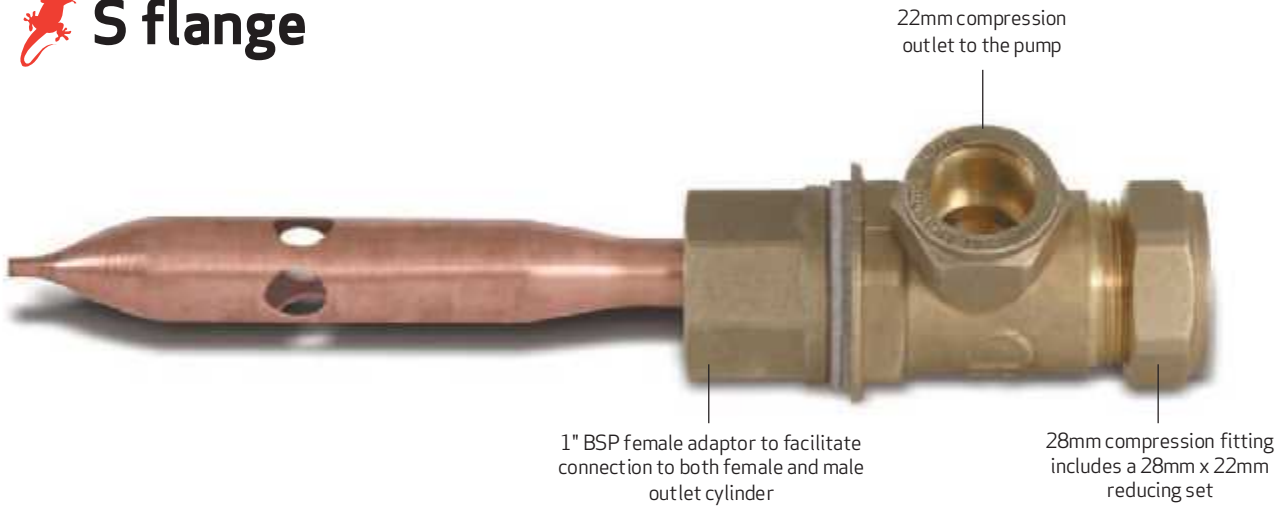

Salamander's uniquely different top entry DZR cylinder flange

- Plumbing is not an exact science and aeration of the supply water to showers and other outlets is a common problem.
- When a pump is fitted to boost the supplies from the cold water storage tank and from the cylinder to showers, baths and basins the risk of aeration is increased many times.

TYPICAL PIPEWORK ARRANGEMENT

Systems without a flange – will risk aeration of the supply water to the pump.

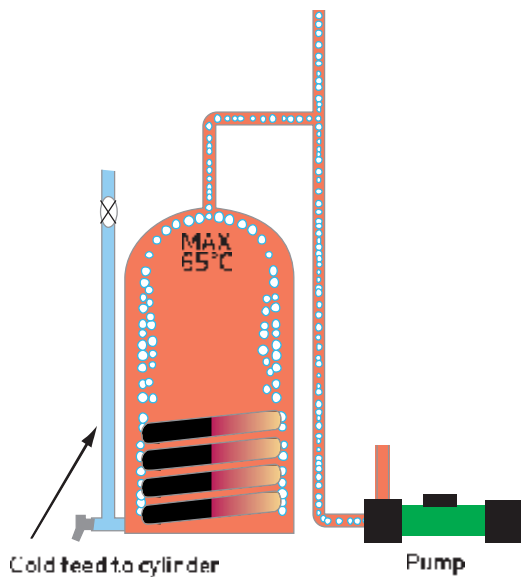

Aeration – aerated supply water to pumps and to showers and other outlets means an increased risk of:

- Unnecessary, perhaps sudden temperature fluctuation at the shower or other outlets.
- A noisy pump.
- Accelerated degradation of the pump's mechanical shaft seals eventually to leak.
- Premature pump breakdown.

A correctly fitted Approved Cylinder flange will mitigate if not prevent these risks.

A quiet life and peace of mind for the customer
An easier life for plumbers

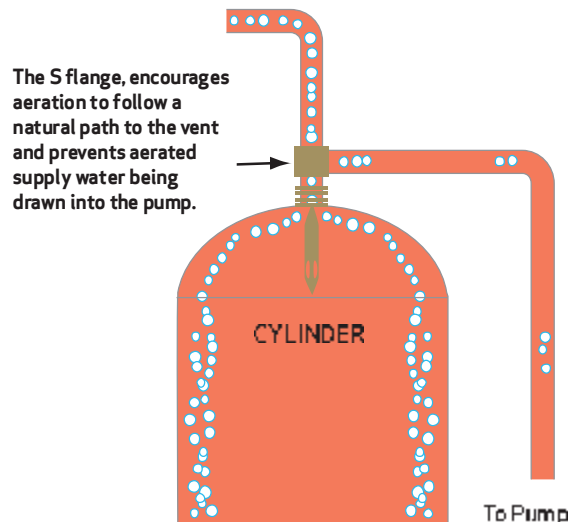



HWS-TMV controller

The HWS-TMV controller is designed to protect booster pumps fitted to systems where the stored domestic hot water temperature is uncontrolled e.g. AGA, SOLID FUEL appliances or AUTOMATIC BOILERS very crudely controlled by the boiler thermostat.

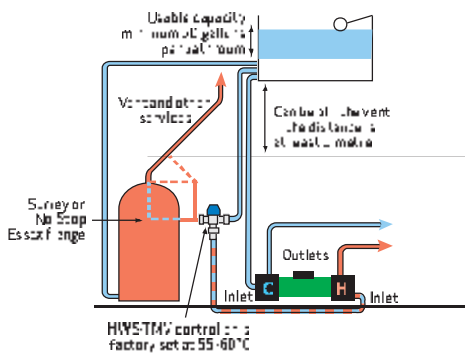

Example of an RSP75 twin with HWS-TMV protection



AV couplers

All Salamander pumps are supplied with AV (anti-vibration) couplers in order to limit the transfer of motor and pump vibration to the associated pipe work.

The beneficial effect of AV couplers is lost if they are bent or twisted on installation.

Each pump Single or Twin pump is supplied with one or two each straight and angled AV couplers. This arrangement of couplers facilitates the connection of the supply pipe work from any direction.





General specification

Applications

All Salamander pumps are designed to boost low pressure Hot and Cold supplies from tank-fed services. When supplies from a water heater or a combination boiler are to be boosted contact the Salamander PumpWise* Helpline (0845 129 5010) for guidance.

Voltage

220-240 volts 50 Hz

Motor type

Capacitor start and run induction type motor with stainless steel shaft and in-built resetting thermal protection (complies with BS5000 part 11).

Pump materials

All moulded components are manufactured from WRAS approved Acetal Copolymer and Glass Coupled Polypropylene.

Inlet pressures (maximum)

ESP 50 CPV 15 feet head (1/2 Bar).

All other Right Pumps 30 feet head (1 Bar).

CT50/75 and New Pearl 50 feet head (1 1/2 Bar).

AV couplers

All Salamander AV couplers are 3/4" BSP Fl x 22mm PushFit with built-in isolating valves except those for RSP 50, RGP 40, NP 50 and NP 55 which are 15mm PushFit.

The AV couplers supplied with the CT 50/85/75 DO NOT HAVE built-in isolating valves.

Mechanical seals

Rotary mechanical face seals comprise a carbon rotary element and a ceramic counter face. This combination is resistant to mineral deposits and to abrasion.

Connections

3/4" BSP Male.

Initiation

ESP CPV pumps are fully automatic for both positive and negative head systems. All other pumps require a natural flow of at least 1 litre per minute from a hot or cold outlet for automatic operation in positive head systems.

Temperature

Maximum fluid temperature 60-65° C. ESP CPV pumps will automatically stop running if the hot water temperature exceeds acceptable limits.

Electrical rating

Single Pumps – Continuous.

Twin pumps continuous except CT 75 and NP 75 which are 30 mins on/off, and RHP 140 and ESP 140 CPV which are 20mins on/off.

All Salamander pumps are fitted with a mains lead and an appropriately fused moulded 3-pin plug.

Continuous improvement

The company operate a policy of continuous development and reserves the right to change any of the specifications of its products without prior notice. All information data and illustrations given in this leaflet may be subject to variation.

Standards and Approvals

Splash proof rating IPX2.

Complies with the requirements of current British and European safety standards for household and similar electrical appliances.

Meets with Compliance with European Community Directives (CE).

Due to continuous improvement and updating, specifications may be altered without prior notice.

** PumpWise – A Salamander initiative to help customers and to provide a support service which is second to none.*



Technical, Sales and Accounts

Technical



Malcolm



Toby



Gerry



Mike



Richard



Christine

Sales



Gill



Sammy



Wendy



Kirsty



Parv

Accounts



Left – Anita
Centre – Mark
Right – Vicky

Sales

Telephone: 0845 377 9160

Facsimile: 0845 377 9180

E-mail: sales@salamanderpumps.co.uk

Salamander Pumps

Salamander Pumped Shower Systems Limited

2-10 St Johns Street, Bedford MK42 0DH

Telephone: 0845 377 9160

Facsimile: 0845 377 9180

E-mail: sales@salamanderpumps.co.uk

