



SERIES 'E' VERTICAL PUMPS

9

P-300S

***RUNS DRY — EFFICIENT AND DEPENDABLE
PERFORMANCE FOR:***

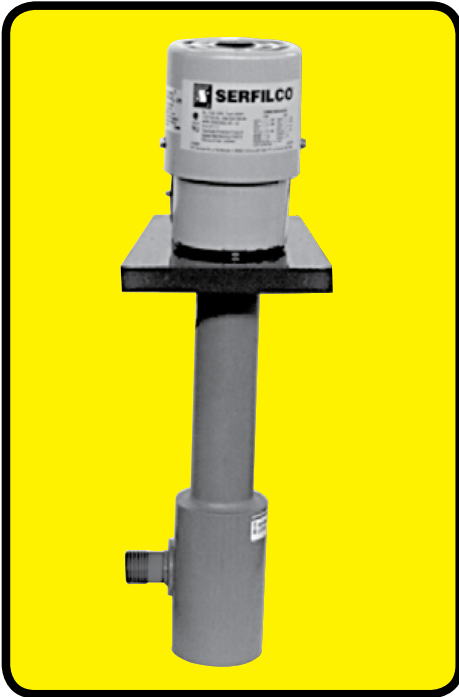

**ACIDS / CAUSTICS / CLEANERS
CHEMICALS / PCB / PLATING
WATER / WASTE WATER**

- **Flows to 20 U.S. GPM or 15 ft. TDH @ 60 Hz**
(63 LPM or 3.2m @ 50 Hz)
- **Non-metallic solution contact**
CPVC w/sleeved shaft & Viton® "O"-ring
Natural polypropylene w/sleeved shaft & Viton "O"-ring
PVDF w/sleeved shaft & Viton "O"-ring
(See a chemical resistance chart)
- **Runs dry — no bearings**
- **Chemical duty motor - 1/8 HP, TEFC,
2-part epoxy finish, stainless steel shaft**
- **Centrifugal — quiet, vibration-free**
- **In- or out-of-tank installation**
- **Shaft vapor seal protects motor bearings
and atmosphere**

The rugged Series 'E' sump pump is a tough, all machined pump designed for years of trouble-free operation. This pump features a cantilevered, sleeved stainless steel shaft which eliminates bearings and seals, resulting in a pump that can run dry without damage. A vapor seal between the rotating shaft and the support column protects the motor. The compound impeller prevents liquid from rising in the column, even at maximum TDH, while the semi-enclosed bottom impeller provides efficient flow performance at low horsepower.

A unique characteristic of the Series 'E' pump is its ability to perform on continuous duty as a level control when an optional suction extension pipe is installed. With the motor energized, the pump will self-prime when liquid is above impeller level. The solution level will then be pumped down to the end of the suction extension, the pump will lose prime, then reprime when liquid again reaches the impeller.

Discharge pipe assembly, suction extension and suction strainer are available options.

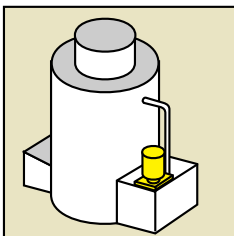

**FUME
SCRUBBING**

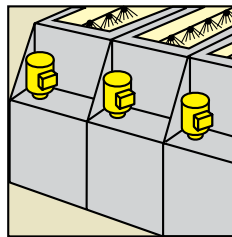

**PCB WET
PROCESSING**

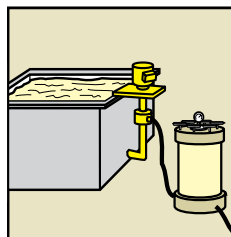

**OUT-OF-TANK PUMPING
and FILTRATION**

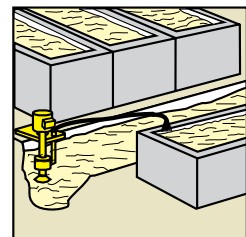

**SUMP DRAINING and
WASTE TREATMENT**



SERIES 'E' PUMP Specifications

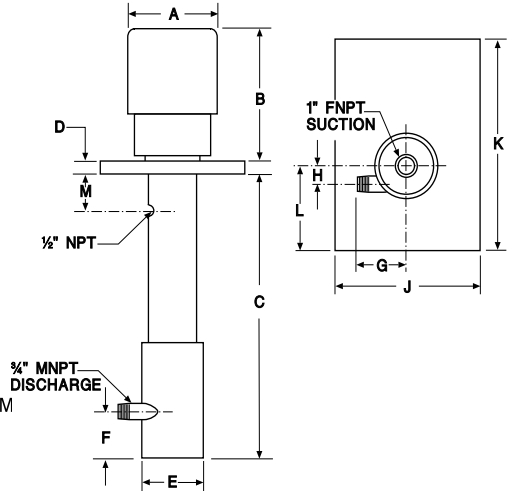
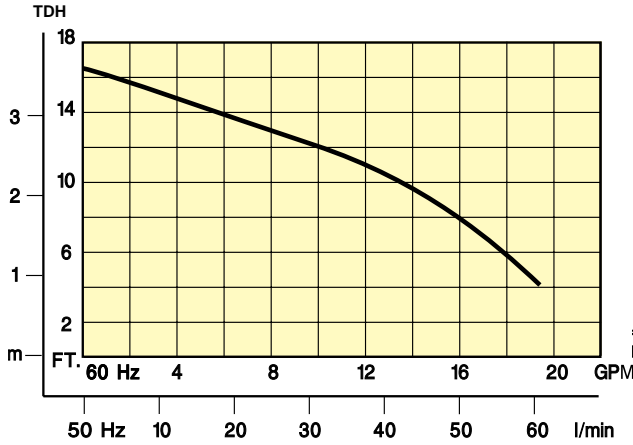

DIMENSIONS												
	A	B	C	D	E	F	G	H	J	K	L	M
in	4	5-7/8	11-7/8	1/2	2-3/4	2-1/4	2-3/8	3/4	6-1/4	8-3/4	3-1/8	1-7/8
mm	102	149	302	13	70	57	60	19	159	222	79	48

TO ORDER, use Price Code No.

MATERIAL	MODEL	1/8 HP MOTOR VOLTAGE	CONNECTIONS (NPT)		PRICE CODE NO.
			SUCTION	DISCHARGE	
PP, Viton*	E3/4SPPV C1/8	115-230/1/50-60 TEFC motor with 8 ft. cord and 3-prong plug.	1" F	3/4" M	45-0030 A
CPVC, Viton*	E3/4SCV C1/8				45-0027 1A
PVDF, Viton*	E3/4SKV C1/8				45-0028 1A

* For EPDM, change **V** to **L** in Model and drop **A** suffix from Price Code No.
Shipping weight 10 Lbs. (4.54 kg.)

OPTIONAL

DESCRIPTION	ADD SUFFIX TO MODEL	ADD TO PRICE CODE NO.
Through hole in standard mounting plate	-MPH	H

DESCRIPTION	ADD SUFFIX TO MODEL	MATERIAL	PRICE CODE NO.
Suction strainer assembly	-ST	Polyethylene PVDF & ECTFE	33-6058 45-0251
Suction extension, 18" (457mm)	-SX	PP	45-0274
		CPVC	45-0208
		PVDF	45-0230
Discharge pipe assembly	-DPA	PP	45-0270
		CPVC	45-0225
		PVDF	45-0228

TYPICAL APPLICATIONS

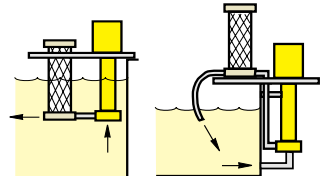

IN-TANK FILTERING **OUT-OF-TANK FILTERING**

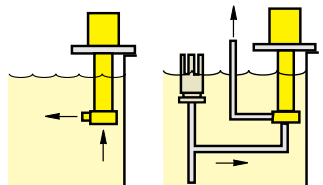

MIXING, AGITATING OR TRANSFER PUMPING **SKIMMING**

Read: "Tips for the successful operation of sump pumps".
See bulletin T-P113